

Zastosowanie

Osiągane wysokie ciśnienia i wydajności pozwalają na zastosowanie tych wentylatorów we wszelkiego rodzaju instalacjach wentylacji ogólnej. Zwarta obudowa sprawia, że wentylatory tego typu posiadają wszystkie zalety wentylatorów osiowych przewyższając je przy tym osiąganymi parametrami. Pozwala to na pokonywanie dużych oporów instalacji powstających w kanałach o małych średnicach oraz bezproblemową współpracę z filtrami i nagrzewnicami kanałowymi. Przykładowe zastosowanie: wentylacja wywiewna i nawiewna mieszkań, biur, sklepów, lokali gastronomicznych, współpraca z domowymi okapami kuchennymi wyposażonymi w filtry przeciw tłuszczowe, etc.

Konstrukcja

Wentylator kanałowy przeznaczony do wentylacji pomieszczeń o niskim stopniu zapylenia, przystosowany do montażu w pozycji pionowej lub poziomej w kanałach wentylacyjnych o średnicach od 100 do 400 mm. Unikalna konstrukcja pozwala na osiągnięcie wysokich ciśnień i wydajności przy minimalnym poziomie hałasu.

Oryginalna konstrukcja umożliwia konserwację bez konieczności demontażu kanałów wentylacyjnych.

Gama wentylatorów TD obejmuje:

- dwustopniowe modele TD dostępne w średnicach 100 i 125 mm (modele TD-160/100, TD-250/100 i TD-350/125).
- trójstopniowe modele TD dostępne w średnicach od 150 do 315 mm (modele TD-500/150, TD-500/160, TD-800/200, TD-800/200N, TD-1000/250, TD-1300/250, TD-2000/315).
- jednostopniowe modele TD dostępne w średnicach od 355 i 400 mm (modele TD-4000/355 i TD-6000/400).

Obudowa modeli 160, 250, 350, 500, 800 jest wykonana z polipropylenu. Obudowa modeli 1000, 1300, 2000, 4000, 6000 jest wykonana z blachy stalowej malowanej farbą epoksydową. Wirniki modeli 1000, 1300, 2000, 4000, 6000 wykonane są z blachy aluminiowej, natomiast 160, 250, 350, 500, 800, 800N z tworzywa sztucznego ABS.

Silnik elektryczny

Wentylatory TD wyposażone są w silniki jednofazowe 230V, 50Hz (modele 160 - 6000), oraz silniki trójfazowe 400V, 50Hz (modele 4000 TRIF, 6000 TRIF).

Silniki modeli od 250 do 2000 (bez 500 i 800 - IP44 klasa izolacji uzwojenia F) wykonane są w stopniu ochrony IP44 oraz klasie izolacji uzwojenia B, modele 4000 i 6000 wykonane są w stopniu ochrony IP54 oraz klasie izolacji uzwojenia F. Silniki wyposażone są w łożyska kulkowe.

Wszystkie silniki jednofazowe przystosowane są do napięciowej regulacji prędkości obrotowej (np. REB, RMB).

Silniki trójfazowe przystosowane są do regulacji falownikiem.

Wentylatory o wielkościach 160 i 250 wyposażone są standardowo w dwubiegowe silniki przystosowane do pracy w dwóch prędkościach obrotowych (zalecany przełącznik biegów REGUL-2).

Wentylatory o wielkościach od 500 do 2000 wyposażone są standardowo w trójbiegowe silniki przystosowane do pracy w trzech prędkościach obrotowych (zalecany przełącznik biegów INTER 4P).

Wszystkie silniki posiadają termiczne zabezpieczenie uzwojenia przed przeciążeniem - topikowe w modelach 160, 250 i 350, a w pozostałych modelach bezpiecznik automatyczny.

Inne

Wykonanie z dodatkowym wyciszeniem - TD SILENT - str. 16

Wykonanie do stref zagrożonych wybuchem - TD EX - str. 771

Wykonanie dachowe - TH - str. 286

Wykonanie dachowe do stref zagrożonych wybuchem - TH EX - str. 774

Oznaczenie

TD	-	800	/	200	N	3V
1		2		3	4	5

1. Nazwa
2. Model
3. Średnica nominalna
4. Wersja (N, TRIFF)
5. Wersja trójstopniowa

Dane techniczne

Typ	prędkość obrotowa [obr/min]	pobór mocy max [W]	natężenie [A]	wydajność max [m³/h]	temperatura pracy [°C]	poziom ciśn. akust. * [dB(A)]	regulator	masa [kg]	ErP	nr artykułu
TD-160/100N SILENT	2400 (HS)	29	0,17	180	-20 +40	25	REB-1 RMB 1,5	1,4	2018 P < 30W	40020710
	2220 (LS)	18	0,11	150		22				
TD-250/100	2140 (HS)	28	0,12	250	-20 +40	34	REB-1 RMB 1,5	2	2018 P < 30W	40020720
	1700 (LS)	22	0,1	200		28				
TD-350/125	2050 (HS)	26	0,11	330	-20 +40	33	REB-1 RMB 1,5	2	2018 P < 30W	40020730
	1590 (LS)	20	0,09	250		24				
TD-500/150 3V	2590 (HS)	53	0,21	560	-20 +60	36	REB-1 RMB 1,5 INTER 4P	2,7	2018	40020745-02
	2150 (MS)	44	0,19	470		33				
TD-500/160 3V	1820 (LS)	41	0,18	390	-20 +60	29	REB-1 RMB 1,5 INTER 4P	2,7	2018	40020740-02
	2590 (HS)	53	0,21	560		36				
TD-800/200N 3V	2190 (HS)	103	0,5	890	-20 +60	39	REB-1 RMB 1,5 INTER 4P	4,9	2018	40020760-01
	1870 (MS)	93	0,47	750		35				
TD-800/200 3V	1660 (LS)	88	0,45	660	-20 +60	36	REB-1 RMB 1,5 INTER 4P	4,9	2018	40020754-01
	2480 (HS)	132	0,55	1040		39				
TD-1000/250 3V	2290 (MS)	133	0,56	940	-20 +60	36	REB-1 RMB 1,5 INTER 4P	4,9	2018	40020754-01
	2080 (LS)	131	0,55	850		34				
TD-1300/250 3V	2790 (HS)	130	0,46	960	-40 +60	38	REB-1 RMB1,5 INTER 4P	9,4	2018	40020770-01
	2620 (MS)	99	0,31	910		37				
TD-2000/315 3V	2510 (LS)	91	0,28	850	-40 +60	36	REB-1 RMB1,5 INTER 4P	9,4	2016	40020780-01
	2510 (HS)	196	0,79	1350		39				
TD-4000/355	2200 (MS)	153	0,61	1 160	-40 +60	36	REB-1 RMB1,5 INTER 4P	9,4	2016	40020780-01
	1980 (LS)	133	0,54	1050		34				
TD-6000/400	2630 (HS)	290	1,03	1830	-40 +60	50	REB-2,5 RMB 1,5 INTER 4P	14	2016	40020790-01
	2420 (MS)	223	0,79	1630		49				
TD-4000/355	2130 (LS)	173	0,64	1430	-40 +60	46	REB-2,5 RMB 3,5	19	2016	40020792
	1360 (230V)	407	1,69	3750		47				
TD-6000/400	1200 (170V)	323	1,83	3230	-40 +60	42	REB-5 RMB 8	36	2016	40020794
	970 (140V)	263	1,87	2630		38				
TD-6000/400	730 (115V)	190	1,72	1950	-40 +40	43	REB-5 RMB 8	36	2016	40020794
	1400 (230V)	680	2,92	5310		42				
TD-6000/400	1320 (170V)	577	3,24	4860	-40 +40	40	REB-5 RMB 8	36	2016	40020794
	1210 (140V)	530	3,66	4440		40				
TD-6000/400	960 (115V)	453	4,06	3580						

ZASILANIE TRÓJFAZOWE

TD-4000/355 TRIF	1150 (50Hz)	309	0,66	3160	-40 +70	37	Falownik 0,37 kW	24,6	2018	40020793
	1000 (40Hz)	188	0,47	2720		34				
	790 (30Hz)	97	0,3	2150		26				
	680 (25Hz)	67	0,26	1800						
TD-6000/400 TRIF	1400 (50Hz)	691	1,49	5330	-40 +60	44	Falownik 0,55 kW	36	2016	40020795
	1130 (40Hz)	384	0,83	4210		41				
	850 (30Hz)	185	0,45	3150		30				
	710 (25Hz)	125	0,39	2650						

* mierzony w odległości 3m od wentylatora.

Charakterystyki pracy

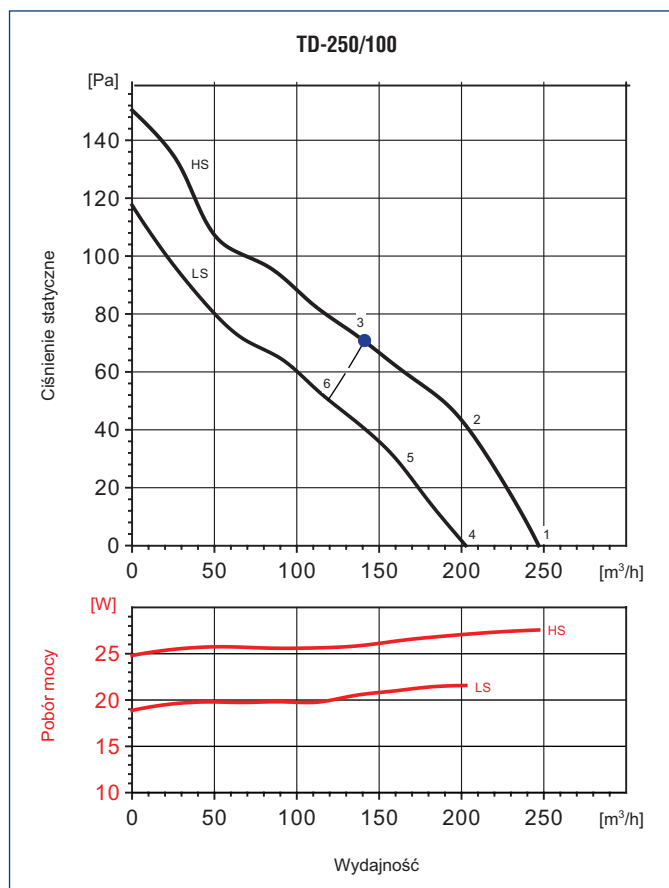
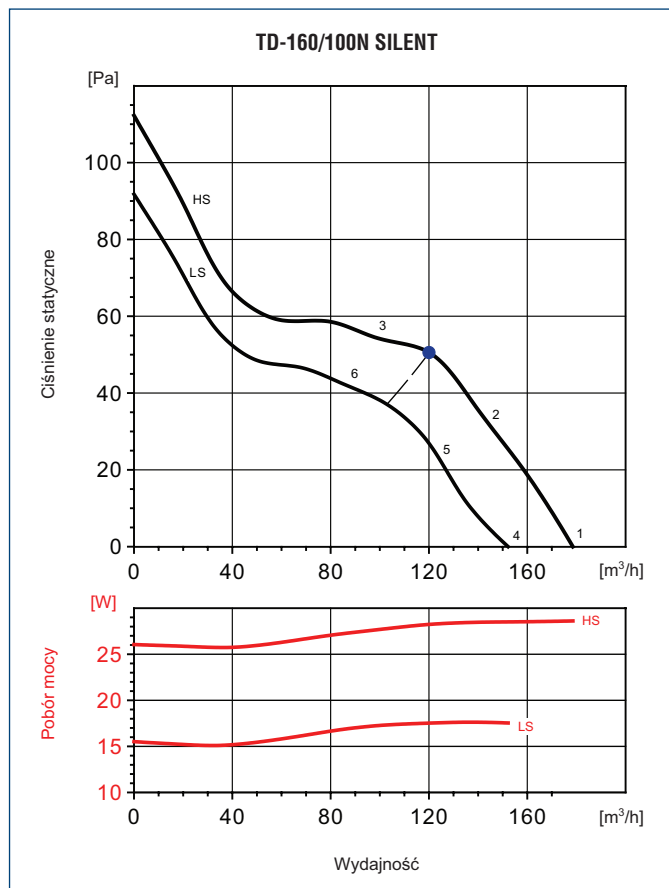

● - punkt najwyższej sprawności wentylatora.

Charakterystyka akustyczna

Częst. Hz/dB(A)	63	125	250	500	1000	2000	4000	8000	L _{WA}	
1	Wlot	22	34	41	47	53	49	40	31	56
	Wylot	22	43	38	50	51	47	41	32	55
	Emitowany	21	27	41	35	36	40	33	22	45
2	Wlot	21	36	39	47	52	48	39	30	55
	Wylot	22	42	37	50	50	46	41	31	54
	Emitowany	20	29	39	35	35	39	32	21	44
3	Wlot	24	37	41	48	52	47	39	30	55
	Wylot	27	42	38	50	51	45	40	31	55
	Emitowany	23	30	41	36	35	38	32	21	45
4	Wlot	22	31	37	45	51	46	38	29	53
	Wylot	22	38	34	48	49	45	39	29	53
	Emitowany	19	27	36	33	35	38	31	21	42
5	Wlot	21	33	37	45	50	46	37	28	53
	Wylot	22	38	35	48	48	44	38	29	52
	Emitowany	18	29	36	33	34	38	30	20	42
6	Wlot	23	34	39	45	50	45	37	28	53
	Wylot	26	38	36	48	49	44	38	28	53
	Emitowany	20	30	38	33	34	37	30	20	43

Częst. Hz/dB(A)	63	125	250	500	1000	2000	4000	8000	L _{WA}	
1	Wlot	26	31	47	54	55	50	40	31	59
	Wylot	25	31	50	56	53	51	41	32	59
	Emitowany	18	22	47	48	51	48	33	24	55
2	Wlot	25	32	46	53	56	51	41	32	59
	Wylot	25	31	49	54	52	50	40	31	58
	Emitowany	17	23	46	47	52	49	34	25	55
3	Wlot	27	33	45	53	55	51	42	34	58
	Wylot	29	34	48	55	51	50	40	31	58
	Emitowany	19	24	45	47	51	49	35	27	55
4	Wlot	24	26	42	48	49	43	32	24	53
	Wylot	24	28	48	49	46	44	33	25	53
	Emitowany	22	25	42	43	43	41	26	19	48
5	Wlot	26	30	42	48	51	45	34	25	54
	Wylot	21	30	47	50	46	44	33	25	53
	Emitowany	24	29	42	43	45	43	28	20	50
6	Wlot	26	32	45	50	53	47	37	28	56
	Wylot	28	32	50	50	49	45	35	27	55
	Emitowany	24	31	45	45	47	45	31	23	52

Charakterystyki pracy

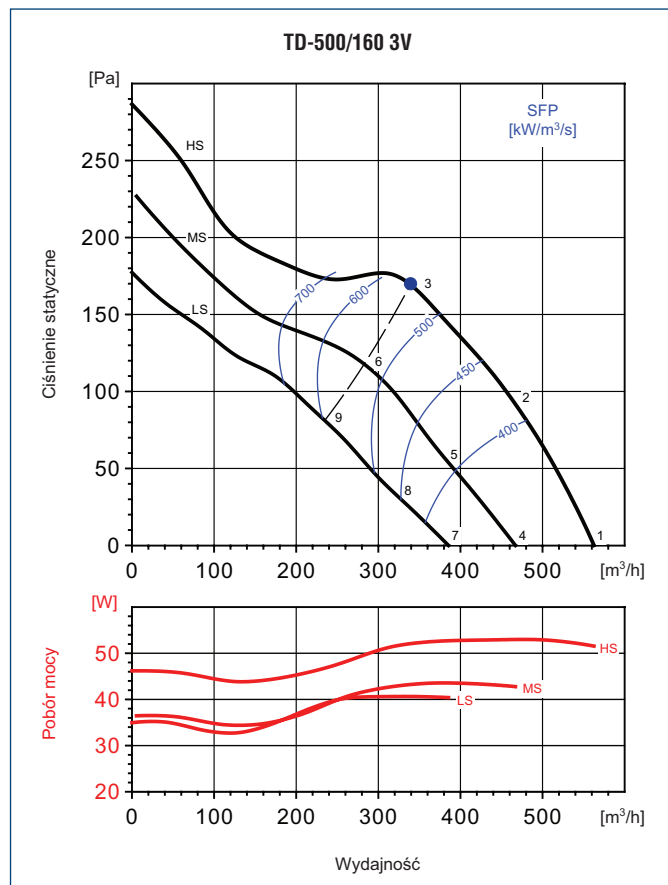
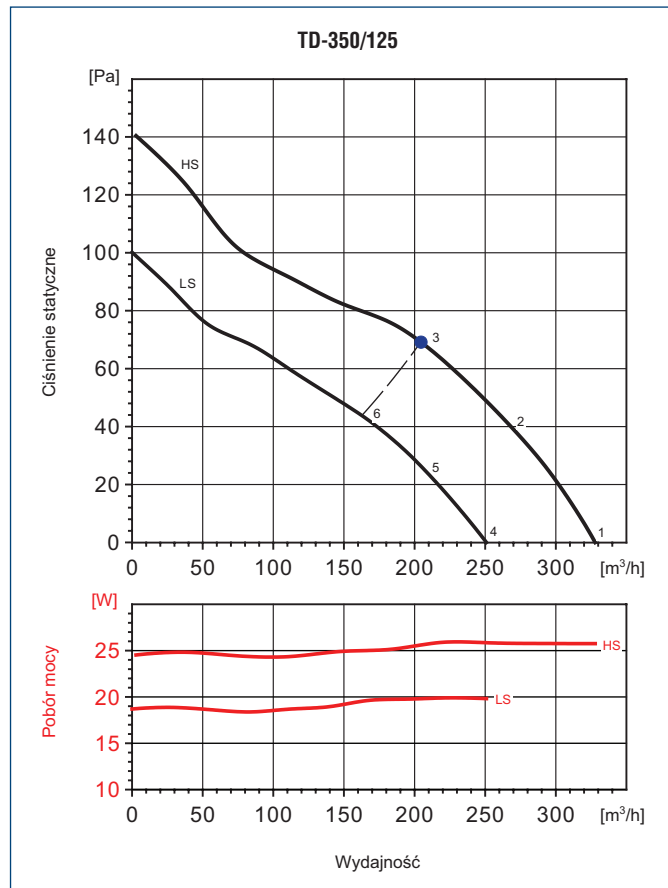

● - punkt najwyższej sprawności wentylatora.

Charakterystyka akustyczna

Częst. Hz/dB(A)	63	125	250	500	1000	2000	4000	8000	L _{WA}	
1	Wlot	27	33	52	51	52	47	38	28	57
	Wylot	23	30	50	51	54	48	38	29	57
	Emitowany	21	27	52	41	45	41	29	17	53
2	Wlot	23	33	55	51	52	46	39	30	58
	Wylot	22	28	52	51	51	48	38	29	57
	Emitowany	17	27	55	41	45	40	30	19	56
3	Wlot	24	34	48	53	54	51	42	32	58
	Wylot	25	33	49	54	53	50	41	31	58
	Emitowany	18	28	48	43	47	45	33	21	52
4	Wlot	20	26	40	46	44	38	30	24	49
	Wylot	22	27	42	47	46	40	29	24	51
	Emitowany	10	23	40	40	38	35	25	18	45
5	Wlot	20	25	40	45	44	38	31	24	49
	Wylot	21	28	39	46	44	40	31	24	49
	Emitowany	10	22	40	39	38	35	26	18	44
6	Wlot	35	33	43	48	50	45	35	26	53
	Wylot	27	32	42	48	48	44	34	25	52
	Emitowany	25	30	43	42	44	42	30	20	49

Częst. Hz/dB(A)	63	125	250	500	1000	2000	4000	8000	L _{WA}	
1	Wlot	26	35	53	58	62	64	57	47	67
	Wylot	28	35	55	57	65	64	56	46	68
	Emitowany	15	25	46	44	49	54	41	27	56
2	Wlot	25	33	51	54	59	61	54	45	64
	Wylot	29	35	53	55	63	61	53	45	66
	Emitowany	14	23	44	40	46	51	38	25	53
3	Wlot	26	36	54	58	60	61	56	46	66
	Wylot	26	34	54	60	64	61	54	45	67
	Emitowany	15	26	47	44	47	51	40	26	54
4	Wlot	23	34	52	54	56	59	51	40	62
	Wylot	28	37	50	54	60	59	49	40	64
	Emitowany	13	21	46	40	44	51	37	22	53
5	Wlot	22	32	49	51	54	56	48	38	60
	Wylot	26	37	47	52	58	55	47	38	61
	Emitowany	12	19	43	37	42	48	34	20	50
6	Wlot	24	39	53	54	56	56	50	40	61
	Wylot	24	36	52	57	59	55	48	39	63
	Emitowany	14	26	47	40	44	48	36	22	52
7	Wlot	23	33	47	49	53	53	44	33	57
	Wylot	24	33	46	50	56	53	43	33	59
	Emitowany	13	22	42	37	42	47	33	18	49
8	Wlot	21	32	43	46	50	50	42	31	54
	Wylot	22	28	42	48	53	49	40	31	56
	Emitowany	11	21	38	34	39	44	31	16	46
9	Wlot	23	36	48	49	51	51	44	32	56
	Wylot	23	35	48	52	54	50	42	32	58
	Emitowany	13	25	43	37	40	45	33	17	48

Charakterystyki pracy

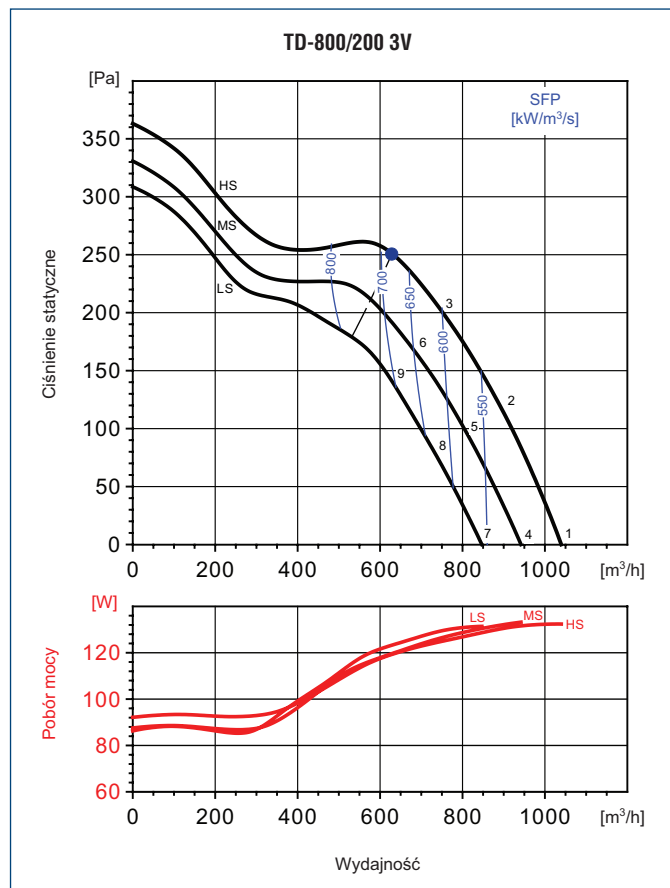
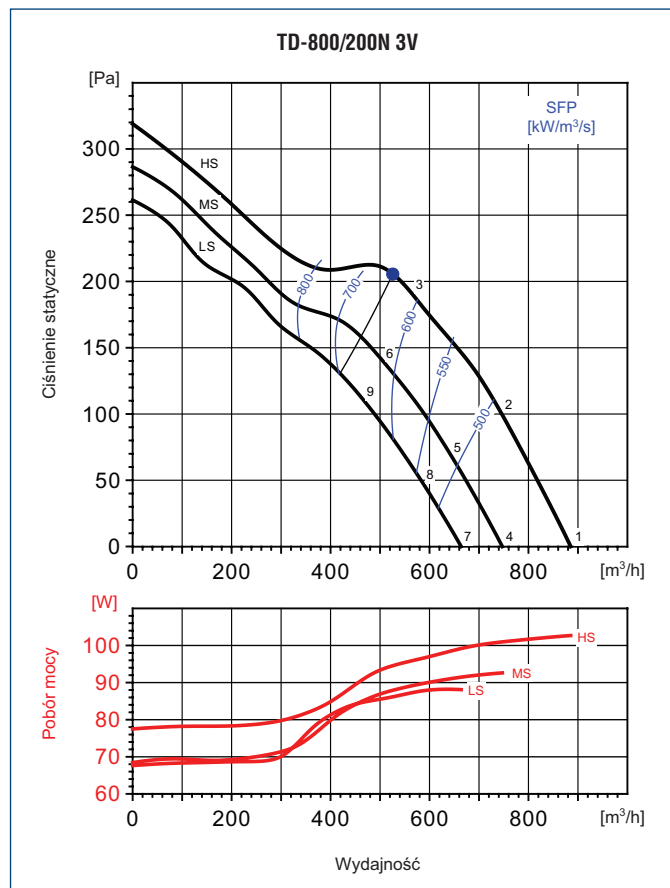

● - punkt najwyższej sprawności wentylatora.

Charakterystyka akustyczna

Częst. Hz/dB(A)	63	125	250	500	1000	2000	4000	8000	L _{WA}	
1	Wlot	23	37	51	56	63	68	61	49	70
	Wylot	44	43	50	59	67	68	62	49	71
	Emitowany	13	24	40	37	51	58	46	30	59
2	Wlot	22	37	49	55	61	67	59	49	69
	Wylot	38	37	48	58	67	67	60	49	71
	Emitowany	12	24	38	36	49	57	44	30	58
3	Wlot	24	36	50	55	62	66	60	51	69
	Wylot	31	34	49	60	67	67	60	49	71
	Emitowany	14	23	39	36	50	56	45	32	57
4	Wlot	21	35	54	52	59	63	55	43	65
	Wylot	39	39	53	57	64	64	57	42	68
	Emitowany	13	21	45	35	47	54	42	26	55
5	Wlot	22	34	51	51	58	62	53	43	64
	Wylot	35	37	49	57	64	63	55	43	67
	Emitowany	14	20	42	34	46	53	40	26	54
6	Wlot	26	36	49	52	59	62	54	46	65
	Wylot	29	35	51	58	64	63	56	45	68
	Emitowany	18	22	40	35	47	53	41	29	54
7	Wlot	32	33	54	50	56	62	50	38	64
	Wylot	35	36	49	54	61	62	52	38	65
	Emitowany	26	20	48	34	45	55	37	22	56
8	Wlot	26	32	48	49	55	59	49	38	61
	Wylot	31	35	48	54	61	60	51	38	64
	Emitowany	20	19	42	33	44	52	36	22	53
9	Wlot	22	33	49	50	56	60	51	41	62
	Wylot	27	35	50	55	62	60	52	40	65
	Emitowany	16	20	43	34	45	53	38	25	54

Częst. Hz/dB(A)	63	125	250	500	1000	2000	4000	8000	L _{WA}	
1	Wlot	25	39	53	58	63	67	60	48	70
	Wylot	41	41	51	57	68	70	64	51	73
	Emitowany	12	25	40	37	50	59	48	31	60
2	Wlot	21	35	49	53	60	67	60	51	69
	Wylot	35	36	47	55	67	13	60	50	68
	Emitowany	12	24	39	35	47	57	45	30	58
3	Wlot	22	35	51	55	61	66	61	52	69
	Wylot	26	31	48	58	67	66	60	49	71
	Emitowany	12	23	40	36	48	55	45	30	56
4	Wlot	22	36	50	55	60	64	57	45	67
	Wylot	38	38	48	55	66	67	61	48	70
	Emitowany	10	22	38	34	47	56	45	28	57
5	Wlot	18	32	46	51	57	65	58	48	66
	Wylot	33	33	45	53	64	10	58	47	66
	Emitowany	9	21	36	32	45	55	42	27	55
6	Wlot	20	33	49	53	59	64	59	50	67
	Wylot	24	29	46	56	65	64	58	47	69
	Emitowany	10	21	38	34	46	53	43	28	54
7	Wlot	20	34	48	52	58	62	55	43	64
	Wylot	36	36	45	52	63	64	59	46	68
	Emitowany	7	20	35	32	45	54	42	25	55
8	Wlot	16	30	44	48	55	62	55	45	64
	Wylot	30	30	42	50	62	8	55	45	63
	Emitowany	7	19	33	30	42	52	40	25	53
9	Wlot	18	31	47	51	57	62	57	48	65
	Wylot	23	27	45	55	63	62	56	46	67
	Emitowany	8	19	36	32	44	51	41	26	52

Charakterystyki pracy

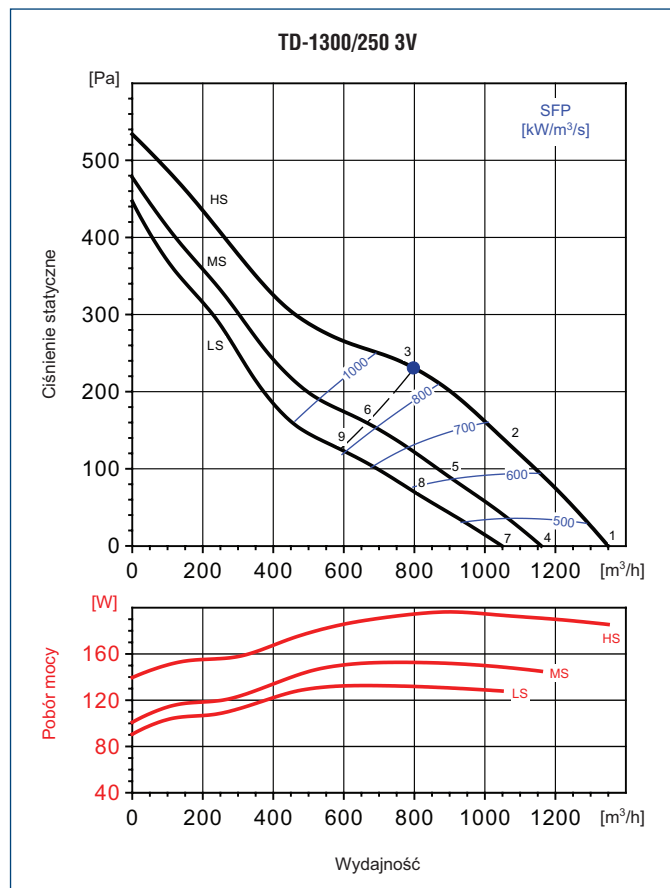
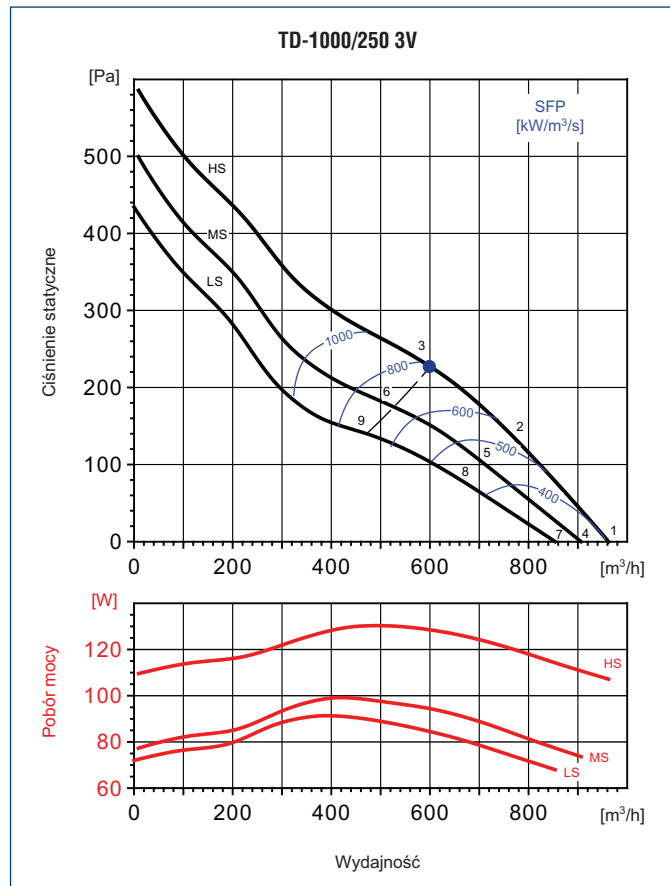

● - punkt najwyższej sprawności wentylatora.

Charakterystyka akustyczna

Częst. Hz/dB(A)		63	125	250	500	1000	2000	4000	8000	L _{WA}
		1	Wlot	35	46	61	67	73	70	63
	Wylot	55	50	64	72	74	75	67	58	79
	Emitowany	20	31	43	44	56	55	44	40	59
2	Wlot	35	50	62	66	72	68	62	53	75
	Wylot	46	45	67	72	74	74	67	57	79
	Emitowany	21	36	45	44	56	55	45	39	59
3	Wlot	36	55	65	65	70	67	61	52	74
	Wylot	40	49	69	73	73	74	67	57	79
	Emitowany	22	41	48	43	54	54	44	39	58
4	Wlot	34	44	60	66	72	69	62	53	75
	Wylot	53	48	63	71	73	73	65	57	78
	Emitowany	19	30	41	42	54	54	43	38	58
5	Wlot	33	48	61	64	70	66	60	51	73
	Wylot	45	44	65	71	72	73	65	55	77
	Emitowany	19	34	44	42	54	53	43	37	57
6	Wlot	34	53	63	63	68	65	59	50	72
	Wylot	38	47	67	71	71	72	65	55	77
	Emitowany	20	39	46	41	52	52	42	36	56
7	Wlot	33	44	59	65	71	68	61	53	74
	Wylot	53	48	62	70	72	73	65	56	77
	Emitowany	18	29	41	42	54	53	42	38	57
8	Wlot	31	46	59	62	69	65	58	49	71
	Wylot	43	42	63	69	70	71	63	53	75
	Emitowany	17	32	42	40	52	51	41	35	55
9	Wlot	31	50	60	60	65	63	56	47	69
	Wylot	35	44	64	68	68	69	62	52	74
	Emitowany	17	36	43	38	49	49	39	34	53

Częst. Hz/dB(A)		63	125	250	500	1000	2000	4000	8000	L _{WA}
		1	Wlot	36	52	70	71	77	74	67
	Wylot	54	54	68	77	81	80	72	61	85
	Emitowany	22	31	44	43	56	56	50	38	60
2	Wlot	40	57	70	70	75	71	64	56	78
	Wylot	45	51	69	78	79	78	69	58	83
	Emitowany	26	36	44	42	54	53	47	35	57
3	Wlot	43	59	69	69	72	69	62	52	76
	Wylot	42	52	70	77	77	75	67	56	82
	Emitowany	29	38	43	41	51	51	45	31	55
4	Wlot	33	49	67	68	74	71	64	56	77
	Wylot	51	51	65	74	78	77	69	58	82
	Emitowany	19	28	41	40	53	53	47	35	57
5	Wlot	36	53	66	66	71	67	60	52	74
	Wylot	41	47	65	74	75	74	65	54	79
	Emitowany	22	32	40	38	50	49	43	31	53
6	Wlot	39	55	65	65	68	65	58	48	72
	Wylot	38	48	66	73	73	71	63	52	77
	Emitowany	25	34	39	37	47	47	41	27	51
7	Wlot	31	47	65	66	72	69	62	54	75
	Wylot	49	49	63	72	76	75	67	56	79
	Emitowany	17	26	39	38	51	51	45	33	54
8	Wlot	34	51	64	64	69	65	58	50	72
	Wylot	38	44	62	71	72	71	62	51	77
	Emitowany	20	30	38	36	48	47	41	29	51
9	Wlot	36	52	62	62	65	62	55	45	70
	Wylot	35	45	63	70	70	68	60	49	75
	Emitowany	22	31	36	34	44	44	38	24	48

Charakterystyki pracy

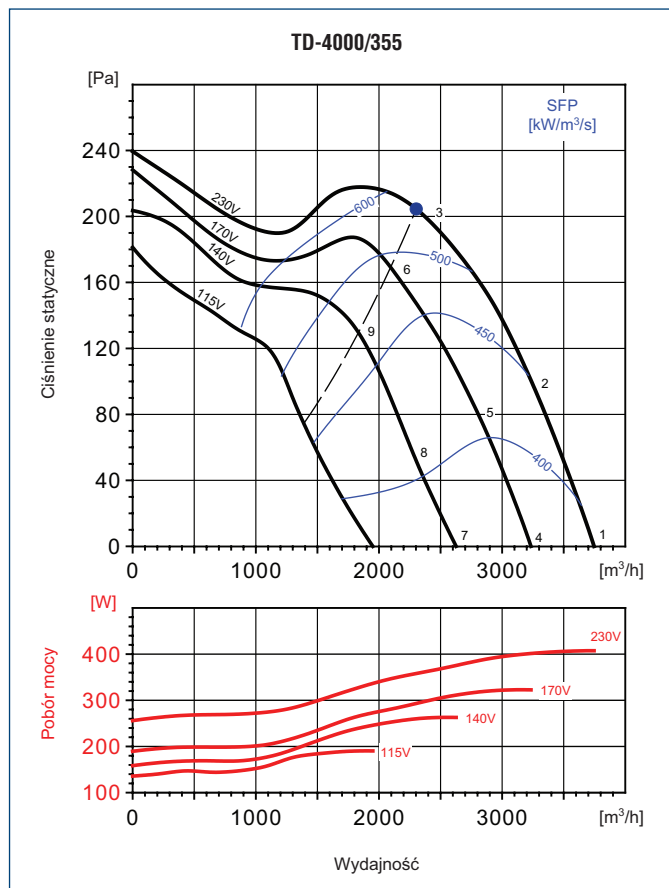
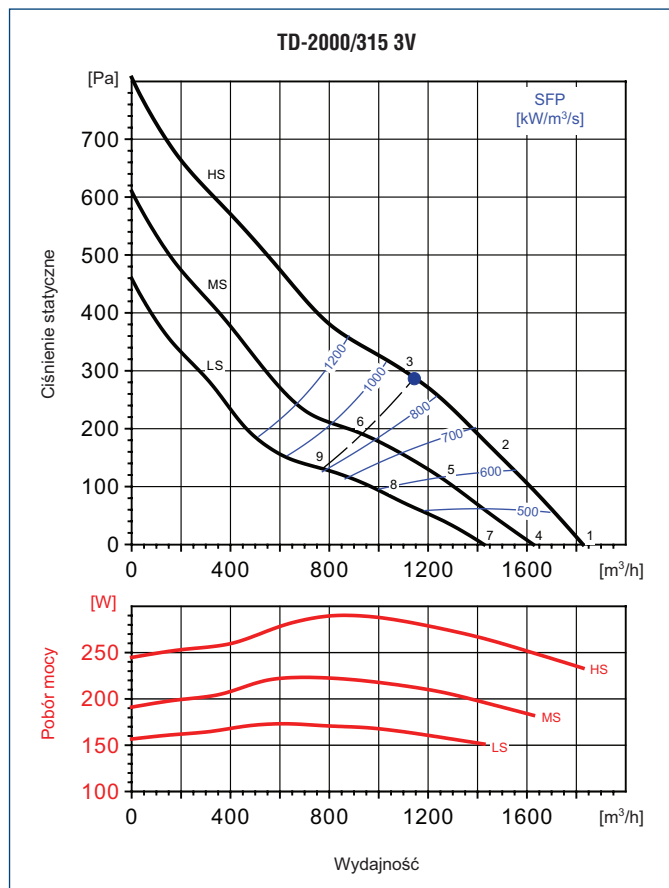

● - punkt najwyższej sprawności wentylatora.

Charakterystyka akustyczna

Częst. Hz/dB(A)		63	125	250	500	1000	2000	4000	8000	L _{WA}
		1	Wlot	39	56	64	69	77	74	67
	Wylot	39	54	71	75	81	80	72	66	85
	Emitowany	38	41	51	59	68	65	58	54	71
2	Wlot	38	57	66	70	78	74	67	61	80
	Wylot	37	54	72	76	84	80	71	65	86
	Emitowany	37	42	53	60	69	65	58	53	71
3	Wlot	38	61	68	68	75	71	65	58	78
	Wylot	40	61	74	75	77	76	68	60	82
	Emitowany	37	46	55	58	66	62	56	50	68
4	Wlot	38	55	63	68	76	73	66	61	79
	Wylot	38	53	70	74	80	79	71	65	83
	Emitowany	37	40	50	58	67	64	57	53	69
5	Wlot	36	55	64	68	76	72	65	59	78
	Wylot	34	51	69	73	81	77	68	62	83
	Emitowany	35	40	51	58	67	63	56	51	69
6	Wlot	34	57	64	64	71	67	61	54	74
	Wylot	36	57	70	71	73	72	64	56	78
	Emitowany	33	42	51	54	62	58	52	46	65
7	Wlot	35	52	60	65	73	70	63	58	76
	Wylot	35	50	67	71	77	76	68	62	80
	Emitowany	34	37	47	55	64	61	54	50	67
8	Wlot	33	52	61	65	73	69	62	56	75
	Wylot	30	47	65	69	77	73	64	58	80
	Emitowany	32	37	48	55	64	60	53	48	66
9	Wlot	30	53	60	60	67	63	57	50	70
	Wylot	32	53	66	67	69	68	60	52	74
	Emitowany	29	38	47	50	58	54	48	42	61

Częst. Hz/dB(A)		63	125	250	500	1000	2000	4000	8000	L _{WA}
		1	Wlot	35	58	63	70	75	75	70
	Wylot	64	65	67	73	76	74	68	60	80
	Emitowany	51	61	65	51	60	53	47	40	68
2	Wlot	33	57	62	67	72	72	67	55	76
	Wylot	58	59	66	70	73	71	65	55	77
	Emitowany	45	55	64	48	57	50	44	35	66
3	Wlot	49	68	76	80	70	68	63	52	82
	Wylot	45	63	66	69	71	68	61	52	75
	Emitowany	32	59	64	47	55	47	40	32	66
4	Wlot	33	59	61	67	72	72	67	55	76
	Wylot	61	63	64	70	73	71	65	55	77
	Emitowany	20	55	59	45	56	51	46	35	62
5	Wlot	31	57	59	65	69	69	64	51	74
	Wylot	56	58	64	68	71	69	62	51	75
	Emitowany	18	53	57	43	53	48	43	31	60
6	Wlot	46	67	63	65	68	67	61	49	74
	Wylot	44	63	65	67	69	67	60	51	74
	Emitowany	33	63	61	43	52	46	40	29	65
7	Wlot	31	59	56	61	66	65	59	46	70
	Wylot	53	58	58	64	67	65	57	46	71
	Emitowany	18	55	54	39	50	44	38	26	58
8	Wlot	30	60	56	60	65	63	57	44	69
	Wylot	47	60	58	62	65	62	54	43	69
	Emitowany	17	56	54	38	49	42	36	24	59
9	Wlot	36	63	59	62	66	66	61	49	71
	Wylot	40	62	61	65	67	65	59	48	72
	Emitowany	23	59	57	40	50	45	40	29	62

Charakterystyki pracy

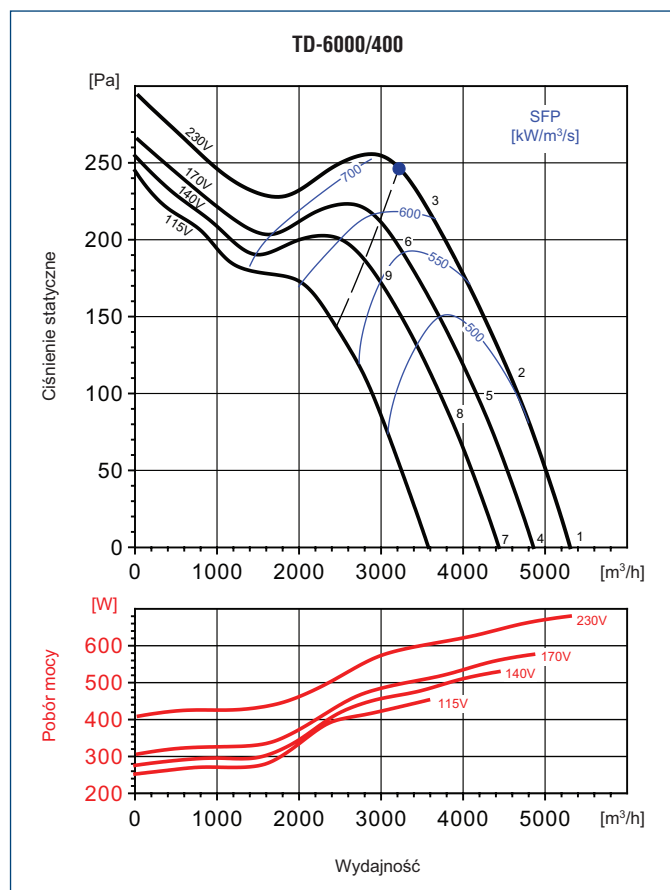
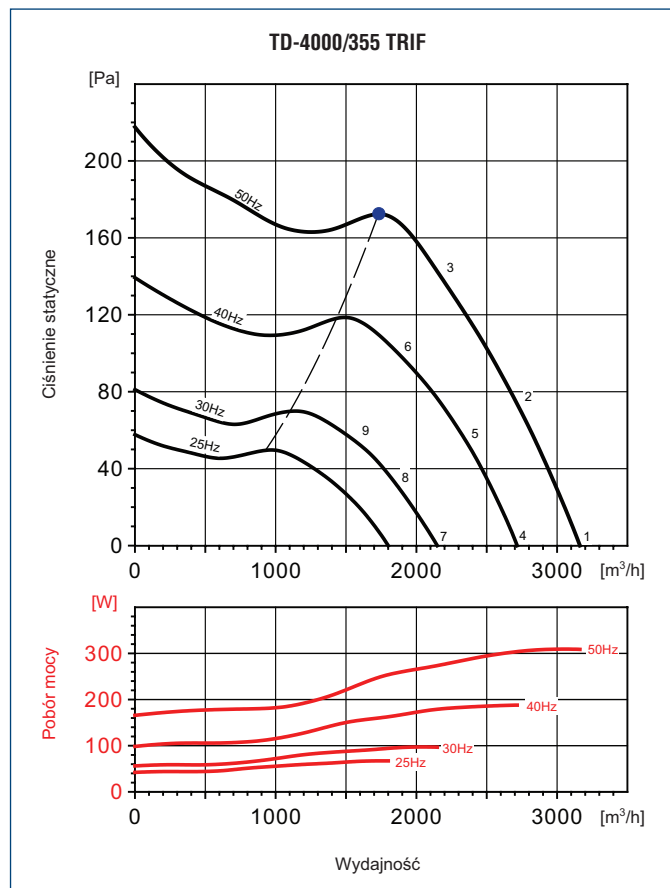

● - punkt najwyższej sprawności wentylatora.

Charakterystyka akustyczna

Częst. Hz/dB(A)	63	125	250	500	1000	2000	4000	8000	L _{WA}	
1	Wlot	32	63	59	64	69	68	63	53	73
	Wylot	60	63	61	66	70	68	61	52	74
	Emitowany	9	54	39	44	53	47	45	34	58
2	Wlot	30	59	56	63	67	66	60	52	71
	Wylot	53	59	57	64	67	65	58	48	71
	Emitowany	7	50	36	43	51	45	42	33	55
3	Wlot	46	65	62	64	67	65	60	52	72
	Wylot	43	61	63	66	67	65	59	50	72
	Emitowany	23	56	42	44	51	44	42	33	58
4	Wlot	29	61	54	60	66	63	57	49	70
	Wylot	54	59	56	62	65	63	55	45	69
	Emitowany	6	52	34	40	50	42	39	30	55
5	Wlot	28	67	52	58	63	61	55	47	70
	Wylot	46	52	53	60	63	60	52	43	67
	Emitowany	5	58	32	38	47	40	37	28	58
6	Wlot	43	63	55	59	64	61	55	47	69
	Wylot	40	61	56	62	64	61	53	44	69
	Emitowany	20	54	35	39	48	40	37	28	55
7	Wlot	26	52	48	54	59	55	50	43	62
	Wylot	50	48	50	56	59	55	49	42	63
	Emitowany	3	43	28	34	43	34	32	24	47
8	Wlot	25	50	46	53	56	52	49	42	60
	Wylot	36	44	47	54	57	52	47	39	60
	Emitowany	2	41	26	33	40	31	31	23	44
9	Wlot	35	52	48	54	56	52	50	41	61
	Wylot	33	49	48	54	56	52	48	38	60
	Emitowany	12	43	28	34	40	31	32	22	46

Częst. Hz/dB(A)	63	125	250	500	1000	2000	4000	8000	L _{WA}	
1	Wlot	42	63	68	75	79	79	72	63	83
	Wylot	72	74	73	77	80	78	72	65	85
	Emitowany	25	46	51	54	62	56	49	40	64
2	Wlot	41	63	68	75	78	77	70	60	82
	Wylot	64	66	70	77	79	77	69	60	83
	Emitowany	24	46	51	54	61	54	47	37	63
3	Wlot	52	69	67	70	74	72	65	55	78
	Wylot	50	67	69	72	73	71	64	54	78
	Emitowany	35	52	50	49	57	49	42	32	60
4	Wlot	40	62	67	74	78	77	71	62	82
	Wylot	68	71	71	76	78	77	70	62	83
	Emitowany	23	43	50	52	61	53	49	39	63
5	Wlot	39	61	67	73	77	76	69	59	81
	Wylot	64	66	69	76	78	75	68	58	82
	Emitowany	22	42	50	51	60	52	47	36	62
6	Wlot	51	69	66	70	72	71	64	54	77
	Wylot	49	67	68	72	73	71	63	54	78
	Emitowany	34	50	49	48	55	47	42	31	58
7	Wlot	39	61	66	71	76	75	68	58	80
	Wylot	65	67	69	74	76	74	67	59	80
	Emitowany	23	42	49	50	59	52	47	36	61
8	Wlot	38	60	66	71	75	74	66	56	79
	Wylot	61	63	68	74	76	73	66	56	80
	Emitowany	22	41	49	50	58	51	45	34	60
9	Wlot	51	72	69	72	74	71	64	54	79
	Wylot	51	68	71	74	74	71	64	54	79
	Emitowany	35	53	52	51	57	48	43	32	60

Charakterystyki pracy

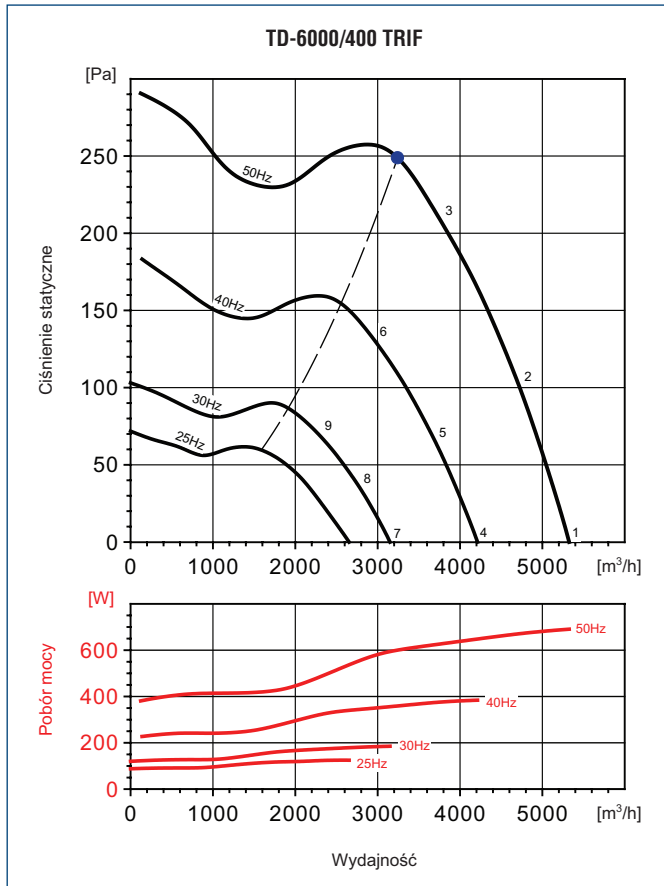

● - punkt najwyższej sprawności wentylatora.

Charakterystyka akustyczna

Częst. Hz/dB(A)	63	125	250	500	1000	2000	4000	8000	L _{WA}	
1	Wlot	41	62	67	75	80	80	72	68	84
	Wylot	72	75	74	76	79	78	71	65	84
	Emitowany	19	46	49	51	63	56	50	46	64
2	Wlot	39	61	68	74	79	79	71	67	83
	Wylot	67	69	71	76	79	76	69	62	83
	Emitowany	17	45	50	50	62	55	49	45	64
3	Wlot	51	70	67	71	74	78	65	66	81
	Wylot	62	65	70	75	77	75	68	60	81
	Emitowany	29	54	49	47	57	54	43	44	61
4	Wlot	37	61	63	69	76	81	67	63	83
	Wylot	66	68	66	71	74	72	66	59	79
	Emitowany	15	45	45	45	59	57	45	41	62
5	Wlot	35	59	63	69	74	81	65	62	82
	Wylot	61	63	65	71	73	70	64	57	77
	Emitowany	13	43	45	45	57	57	43	40	60
6	Wlot	46	64	60	64	72	81	60	59	82
	Wylot	55	61	64	69	72	69	63	55	76
	Emitowany	24	48	42	40	55	57	38	37	60
7	Wlot	33	58	56	62	66	65	58	51	70
	Wylot	57	59	57	64	67	64	58	52	71
	Emitowany	11	42	38	38	49	41	36	29	51
8	Wlot	32	58	55	62	65	63	55	51	69
	Wylot	51	56	56	64	65	61	55	52	69
	Emitowany	10	42	37	38	48	39	33	29	50
9	Wlot	36	59	55	60	64	62	54	52	68
	Wylot	45	56	56	62	65	61	54	52	69
	Emitowany	14	43	37	36	47	38	32	30	49

Wymiary [mm]

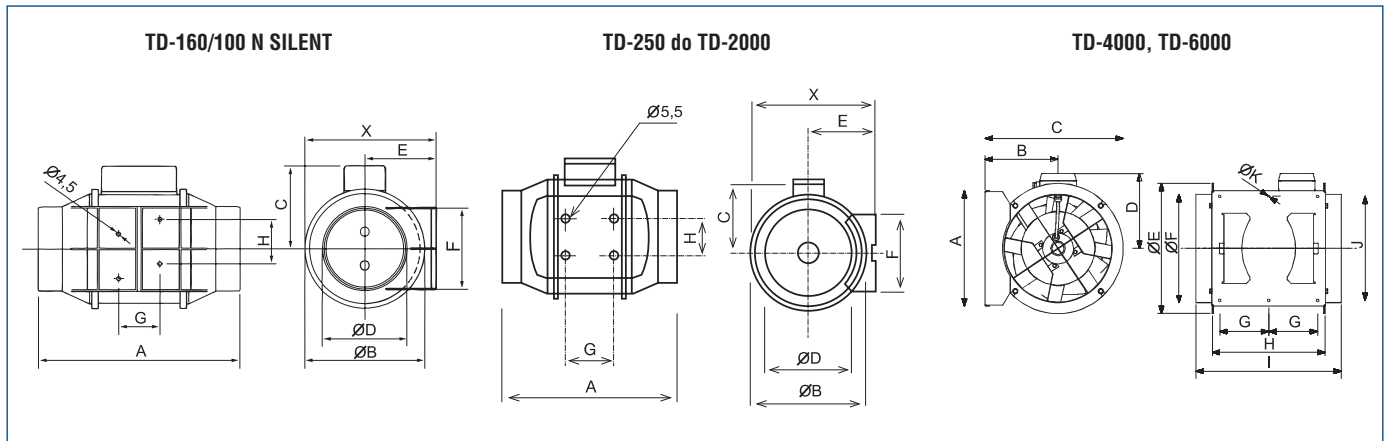

Typ	X	A	ØB	C	ØD	E	F	G	H
TD-160/100N SILENT	151	232	135,5	35,5	97	82	95	47,5	51,1
TD-250/100	188	303	176	115	97	100	90	80	60
TD-350/125	188	258	176	115	123	100	90	80	60
TD-500/150	212	295	200	127	147	112	130	80	60
TD-500/160	212	295	200	127	157	112	130	80	60
TD-800/200N	232,5	302	217	141	198	124	140	100	94
TD-800/200	232,5	302	217	141	198	124	140	100	94
TD-1000/250	291	386	272	192	248	155	168	145	140
TD-1300/250	291	386	272	192	248	155	168	145	140
TD-2000/315	356	450	336	224	312	188	210	182	178

Typ	A	B	C	D	ØE	ØF	G	H	I	J	ØK
TD-4000/355	377	238	451	224	426	354	150	368	474	340	8,5
TD-6000/400	407	249	492	267	487	399	160	425	547	370	8,5

Akcesoria montażowe

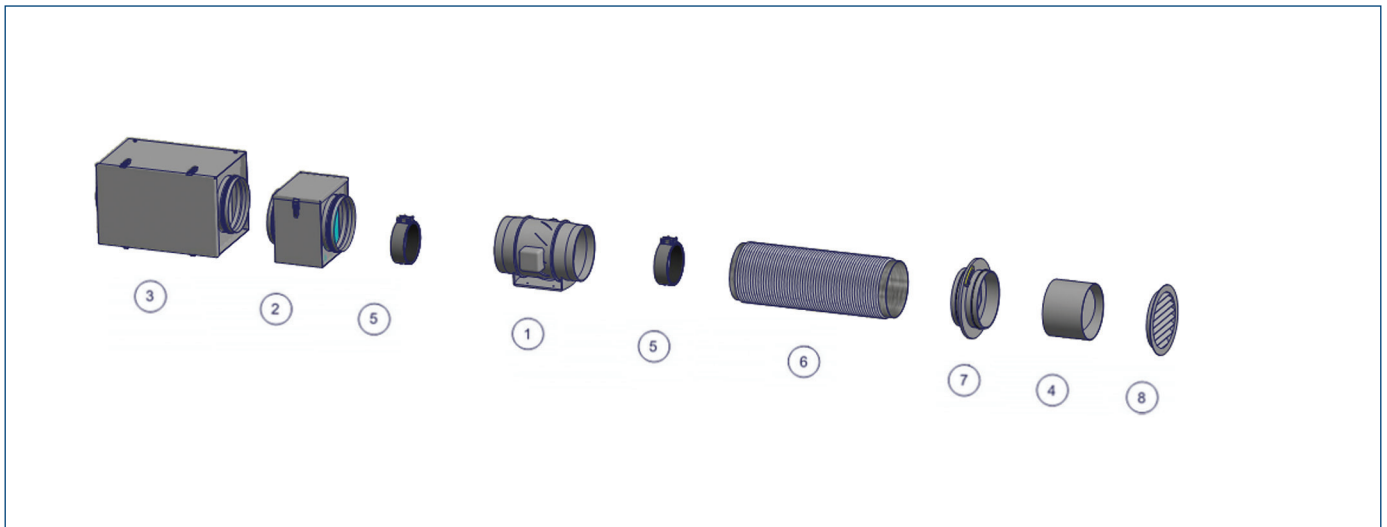

1 Wentylator	2 filtr kanałowy DF	3 filtr kanałowy DF-K					
		wkład filtracyjny do DF-K					
		EU3	EU5	EU7	EU9	H13	
TD-160/100N SILENT	40520610	40521710	40520800	40520805	40520810	40520820	40520822
TD-250/100	40520610	40521710	40520800	40520805	40520810	40520820	40520822
TD-350/125	40520620	40521715	40520800	40520805	40520810	40520820	40520822
TD-500/150 3V	40520630*	40521720*	40520800*	40520805*	40520810*	40520820*	40520822*
TD-500/160 3V	40520630	40521720	40520800	40520805	40520810	40520820	40520822
TD-800/200 3V	40520640	40521725	40520800	40520805	40520810	40520820	40520822
TD-800/200N 3V	40520640	40521725	40520800	40520805	40520810	40520820	40520822
TD-1000/250 3V	40520650	40521730	40520800	40520805	40520810	40520820	40520822
TD-1300/250 3V	40520650	40521730	40520800	40520805	40520810	40520820	40520822
TD-2000/315 3V	40520660	40521735	40520830	40520835	40520840	-	-
TD-4000/355	40520670	40521740	40520830	40520835	40520840	-	-
TD-6000/400	40520675	40521745	40520830	40520835	40520840	-	-
TD-4000/355 TRIF	40520670	40521740	40520830	40520835	40520840	-	-
TD-6000/400 TRIF	40520675	40521745	40520830	40520835	40520840	-	-

1 Wentylator	4 klapa zwrotna CAR	5 złącze przeciwdrgan. ACOP PL	6 łuknik akustyczny AKU COMP		7 przepustnica soczewk. IRIS	8 kratka wentylacyjna KWO
			0,6m	1,2m		
TD-160/100N SILENT	40521010	40521810	40521510	40521610	19527100	40522520
TD-250/100	40521010	40521810	40521510	40521610	19527100	40522520
TD-350/125	40521020	40521815	40521520	40521620	19527125	40522530
TD-500/150 3V	40521029	40521818	40521530*	40521630*	19527160*	40522540*
TD-500/160 3V	40521030	40521820	40521530	40521630	19527160	40522540
TD-800/200 3V	40521040	40521825	40521540	40521640	19527200	40522550
TD-800/200N 3V	40521040	40521825	40521540	40521640	19527200	40522550
TD-1000/250 3V	40521050	40521830	40521550	40521650	19527250	40522560
TD-1300/250 3V	40521050	40521830	40521550	40521650	19527250	40522560
TD-2000/315 3V	40521060	40521835	40521560	40521660	19527315	40522570
TD-4000/355	40521065	40521840	-	-	-	-
TD-6000/400	40521070	40521845	-	-	19527400	40522580
TD-4000/355 TRIF	40521065	40521840	-	-	-	-
TD-6000/400 TRIF	40521070	40521845	-	-	-	40522580

* akcesoria montażowe dedykowane do średnicy 160 mm

Akcesoria elektryczne

Wentylator	przełącznik biegów 2-stopniowy	przełącznik biegów 3-stopniowy	termostat ścienny	termostat kanałowy	czujnik zanieczyszczeń	czujnik wilgotności	regulator tyrystorowy		
	REGUL 2	INTER 4P	TS	TK-1	SQA	HIG-2	REB N	REB NE	TLR
TD-160/100N SILENT	40025000	-	40025345	40025330	40025140	40025150	40025010	40025020	40025025
TD-250/100	40025000	-	40025345	40025330	40025140	40025150	40025010	40025020	40025025
TD-350/125	40025000	-	40025345	40025330	40025140	40025150	40025010	40025020	40025025
TD-500/150 3V	-	40024990	40025345	40025330	40025140	40025150	40025010	40025020	40025025
TD-500/160 3V	-	40024990	40025345	40025330	40025140	40025150	40025010	40025020	40025025
TD-800/200 3V	-	40024990	40025345	40025330	40025140	40025150	40025010	40025020	40025025
TD-800/200N 3V	-	40024990	40025345	40025330	40025140	40025150	40025010	40025020	40025025
TD-1000/250 3V	-	40024990	40025345	40025330	40025140	40025150	40025010	40025020	40025025
TD-1300/250 3V	-	40024990	40025345	40025330	40025140	40025150	40025010	40025020	40025025
TD-2000/315 3V	-	40024990	40025345	40025330	40025140	40025150	40025030	40025040	40025025
TD-4000/355	-	-	40025345	40025330	40025140	40025150	40025030	40025040	40025045
TD-6000/400	-	-	40025345	40025330	40025140 + stycznik	40025150	40025051	40025051	-
TD-4000/355 TRIF	-	-	40025345 + stycznik	40025330 + stycznik	40025140+ stycznik	40025150 + stycznik	-	-	-
TD-6000/400 TRIF	-	-	-	-	-	-	-	-	-

Wentylator	11-stopniowy regulator tyrystorowy	2-nastawowy 6-biegowy regulator tyrystorowy	REB-4 AUTO	ERV	regulator transformatorowy	regulator transformatorowy 2-nastawowy		falownik
	IRF	RND-1			RMB	SC2	SC2A	
TD-160/100N SILENT	-	40025630	40025048	40025046	40025060	40025250	40025251	-
TD-250/100	-	40025630	40025048	40025046	40025060	40025250	40025251	-
TD-350/125	-	40025630	40025048	40025046	40025060	40025250	40025251	-
TD-500/150 3V	-	40025630	40025048	40025046	40025060	40025250	40025251	-
TD-500/160 3V	-	40025630	40025048	40025046	40025060	40025250	40025251	-
TD-800/200 3V	40015154	40025630	40025048	40025046	40025060	40025250	40025251	-
TD-800/200N 3V	40015154	40025630	40025048	40025046	40025060	40025250	40025251	-
TD-1000/250 3V	40015154	40025630	40025048	40025046	40025060	40025250	40025251	-
TD-1300/250 3V	40015154	40025630	40025048	40025046	40025060	40025250	40025251	-
TD-2000/315 3V	40015154	40025630	40025048	40025046	40025060	40025250	40025251	-
TD-4000/355	40015154	40025630	40025048	40025046	40025070	40025252	40025253	-
TD-6000/400	40015154	-	40025048	40025053	40025080	40025256	40025257	-
TD-4000/355 TRIF	-	-	-	-	-	-	-	40016302
TD-6000/400 TRIF	-	-	-	-	-	-	-	40016312

Akcesoria

								
filtr DF str. 158	zest. filtr. DFK...+EU str. 159	nagrzewnica DH/DH-R str. 150	klapa zwrotna CAR str. 162	złącze p-drg. ACOP-PL str. 161	tłumik AKU-COMP str. 156	kratka KWO str. 921	anemostat naw. AKT/AKK str. 908	przepustnica IRIS str. 163
								
regulator REGUL-2 str. 898	regulator INTER 4P str. 892	regulator REB str. 892	regulator RMB str. 892	higrostat HIG-2 str. 896	czujnik SQA str. 896	termostat TS str. 896	termostat TK-1 str. 896	TWIN BASE str. 37
								presostat str. 897

SWM*				
	Nazwa produktu	TD-160/100N SILENT	TD-250/100	TD-350/125
a	Nazwa dostawcy	VENTURE INDUSTRIES / SOLER&PALAU	VENTURE INDUSTRIES / SOLER&PALAU	VENTURE INDUSTRIES / SOLER&PALAU
b	Numer artykułu	40020710	40020720	40020730
c	JZE umiarkowany (SEC Avarage) [kWh/m ² rok]	-11,1	-12,3	-13,7
c	JZE chłodny (SEC cold)	-27,5	-28,7	-30,1
c	JZE ciepły (SEC warm)	-1,7	-2,9	-4,3
c	JZE (SEC) klasa	nie dotyczy	nie dotyczy	nie dotyczy
d	Kategoria urządzenia	SWM (RVU)	SWM (RVU)	SWM (RVU)
d	Typ urządzenia	JSW (UVU)	JSW (UVU)	JSW (UVU)
e	Napęd	2-biegowy	2-biegowy	2-biegowy
f	Typ odzysku ciepła	brak	brak	brak
g	Sprawność temperaturowa [%]	nie dotyczy	nie dotyczy	nie dotyczy
h	Maksymalny przepływ powietrza [m ³ /h]	125	185	248
i	Maksymalny pobór mocy [W]	28,3	26,9	25,9
j	Moc akustyczna [dB(A)]	43	50	49
k	Wartość odniesienia natężenia przepływu [m ³ /s]	0,024	0,037	0,05
l	Wartość odniesienia różnicy ciśnienia [Pa]	43	46	38
m	JPM/SPI [W/m ³ /h]	0,193	0,154	0,110
n	CRS/CTRL	1	1	1
o	Stopień zewnętrznych przecieków powietrza [%]	5	5	5
p	Stopień mieszania	nie dotyczy	nie dotyczy	nie dotyczy
q	Ostrzeżenia o konieczności wymiany filtra	nie dotyczy	nie dotyczy	nie dotyczy
r	Instrukcja instalowania kratki wentylacyjnych	nie dotyczy	nie dotyczy	nie dotyczy
s	Strona internetowa	www.venture.pl www.solerpalau.com	www.venture.pl www.solerpalau.com	www.venture.pl www.solerpalau.com
t	Podatność przepływu na zmiany ciśnienia	nie dotyczy	nie dotyczy	nie dotyczy
u	Szczelność	nie dotyczy	nie dotyczy	nie dotyczy
v	Roczne zużycie energii elektrycznej - umiarkowany [kWh/m ² rok]	242	193	138
v	Roczne zużycie energii elektrycznej - chłodny [kWh/m ² rok]	242	193	138
v	Roczne zużycie energii elektrycznej - ciepły [kWh/m ² rok]	242	193	138
w	ROO klimat chłodny			
w	ROO klimat umiarkowany			
w	ROO klimat ciepły			
	MISC	1,1	1,1	1,1
	x-wykładnik	1,2	1,2	1,2

* SWM - "system wentylacyjny przeznaczony do budynków mieszkalnych" - zgodnie z Rozporządzeniem Komisji (UE) nr 1254/2014

SWNM*							
	Nazwa produktu	TD-500/150 3V	TD-500/160 3V	TD-800/200N 3V	TD-800/200 3V	TD-1000/250 3V	TD-1300/250 3V
a	Nazwa dostawcy	VENTURE INDUSTRIES/ SOLER&PALAU	VENTURE INDUSTRIES/ SOLER&PALAU	VENTURE INDUSTRIES/ SOLER&PALAU	VENTURE INDUSTRIES/ SOLER&PALAU	VENTURE INDUSTRIES/ SOLER&PALAU	VENTURE INDUSTRIES/ SOLER&PALAU
b	Numer artykułu	40020745-02	40020740-02	40020760-01	40020754-01	40020770-01	40020780-01
c	Kategoria urządzenia	SWNM (NRVU)	SWNM (NRVU)	SWNM (NRVU)	SWNM (NRVU)	SWNM (NRVU)	SWNM (NRVU)
c	Typ urządzenia	JSW (UVU)	JSW (UVU)	JSW (UVU)	JSW (UVU)	JSW (UVU)	JSW (UVU)
d	Napęd	3-biegowy	3-biegowy	3-biegowy		3-biegowy	3-biegowy
e	Typ odzysku ciepła	nie dotyczy	nie dotyczy	nie dotyczy	nie dotyczy	nie dotyczy	nie dotyczy
f	Sprawność temperaturowa [%]	nie dotyczy	nie dotyczy	nie dotyczy	nie dotyczy	nie dotyczy	nie dotyczy
g	Znamionowe natężenie przepływu w SWNM w [m³/s]	0,146	0,094	0,146	0,174	0,17	0,222
h	Efektywny pobór mocy (w kW)	0,094	0,052	0,094	0,119	0,13	0,194
i	JMWint w W/(m³/s)	nie dotyczy	nie dotyczy	nie dotyczy	nie dotyczy	nie dotyczy	nie dotyczy
j	Prędkość czołowa w m/s	4,5	3,6	4,5	5,4	3,4	4,5
k	Δps, ext (Pa)	204	168	204	249	228	230
l	Δps, int (Pa)	nie dotyczy	nie dotyczy	nie dotyczy	nie dotyczy	nie dotyczy	nie dotyczy
m	Δps, add (Pa)	nie dotyczy	nie dotyczy	nie dotyczy	nie dotyczy	nie dotyczy	nie dotyczy
n	sprawność statyczna wentylatora [%]	31,5	30,4	31,5		29,6	26,2
o	Stopień zewnętrznych przecieków powietrza [%]	5	5	5	5	3	5
p	Stopień wewnętrznych przecieków powietrza [%]	nie dotyczy	nie dotyczy	nie dotyczy	nie dotyczy	nie dotyczy	nie dotyczy
q	efektywność energetyczna filtra	nie dotyczy	nie dotyczy	nie dotyczy	nie dotyczy	nie dotyczy	nie dotyczy
r	Ostrzeżenia o konieczności wymiany filtra	nie dotyczy	nie dotyczy	nie dotyczy	nie dotyczy	nie dotyczy	nie dotyczy
s	L _{WA} dB(A)	57	54	57	60	59	55
	Strona internetowa	www.venture.pl www.solerpalau.com	www.venture.pl www.solerpalau.com	www.venture.pl www.solerpalau.com	www.venture.pl www.solerpalau.com	www.venture.pl www.solerpalau.com	www.venture.pl www.solerpalau.com

SWNM*						
	Nazwa produktu	TD-2000/315 3V	TD-4000/355	TD-6000/400	TD-4000/355 TRIF	TD-6000/400 TRIF
a	Nazwa dostawcy	VENTURE INDUSTRIES/ SOLER&PALAU	VENTURE INDUSTRIES/ SOLER&PALAU	VENTURE INDUSTRIES/ SOLER&PALAU	VENTURE INDUSTRIES/ SOLER&PALAU	VENTURE INDUSTRIES/ SOLER&PALAU
b	Numer artykułu	40020790-01	40020792	40020794	40020793	40020795
c	Kategoria urządzenia	SWNM (NRVU)	SWNM (NRVU)	SWNM (NRVU)	SWNM (NRVU)	SWNM (NRVU)
c	Typ urządzenia	JSW (UVU)	JSW (UVU)	JSW (UVU)	JSW (UVU)	JSW (UVU)
d	Napęd	3-biegowy	wielobiegowy	wielobiegowy	wielobiegowy	wielobiegowy
e	Typ odzysku ciepła	nie dotyczy	nie dotyczy	nie dotyczy	nie dotyczy	nie dotyczy
f	Sprawność temperaturowa [%]	nie dotyczy	nie dotyczy	nie dotyczy	nie dotyczy	nie dotyczy
g	Znamionowe natężenie przepływu w SWNM w [m³/s]	0,319	0,639	0,892	0,482	0,899
h	Efektywny pobór mocy (w kW)	0,282	0,357	0,586	0,249	0,665
i	JMWint w W/(m³/s)	nie dotyczy	nie dotyczy	nie dotyczy	nie dotyczy	nie dotyczy
j	Prędkość czołowa w m/s	4,1	6,5	7,1	4,9	7,2
k	Δps, ext (Pa)	289	204	245	173	248
l	Δps, int (Pa)	nie dotyczy	nie dotyczy	nie dotyczy	nie dotyczy	nie dotyczy
m	Δps, add (Pa)	nie dotyczy	nie dotyczy	nie dotyczy	nie dotyczy	nie dotyczy
n	sprawność statyczna wentylatora [%]	32,6	36,6	nie dotyczy	nie dotyczy	nie dotyczy
o	Stopień zewnętrznych przecieków powietrza [%]	5	5	5	5	5
p	Stopień wewnętrznych przecieków powietrza [%]	nie dotyczy	nie dotyczy	nie dotyczy	nie dotyczy	nie dotyczy
q	efektywność energetyczna filtra	nie dotyczy	nie dotyczy	nie dotyczy	nie dotyczy	nie dotyczy
r	Ostrzeżenia o konieczności wymiany filtra	nie dotyczy	nie dotyczy	nie dotyczy	nie dotyczy	nie dotyczy
s	L _{WA} dB(A)	68	66	64	58	64
	Strona internetowa	www.venture.pl www.solerpalau.com	www.venture.pl www.solerpalau.com	www.venture.pl www.solerpalau.com	www.venture.pl www.solerpalau.com	www.venture.pl www.solerpalau.com

* SWNM - "system wentylacyjny przeznaczony do budynków niemieszkalnych" - zgodnie z Rozporządzeniem Komisji (UE) nr 1253/2014